



MOMO C160 Base with Pole Component, for Motion and Motion Plus, 60 cm (white)

Key Benefits

- Height Adjustable
- Suitable for one, two or a whole series of monitors
- Easy install
- Flexible modular system
- TÜV certified / 10-year guarantee

Build your ideal monitor arm The MOMO C160 Base with Pole Component, 60 cm, is part of MOMO Motion and Motion+. Specially designed for desk mounting. Endless possibilities Create a multi-monitor set-up with just a few components. Including both straight and angled positions. MOMO monitor arm accessories and components are installed using just one allen (hex) key, cleverly integrated into the product. So you'll always have the right tool at hand.

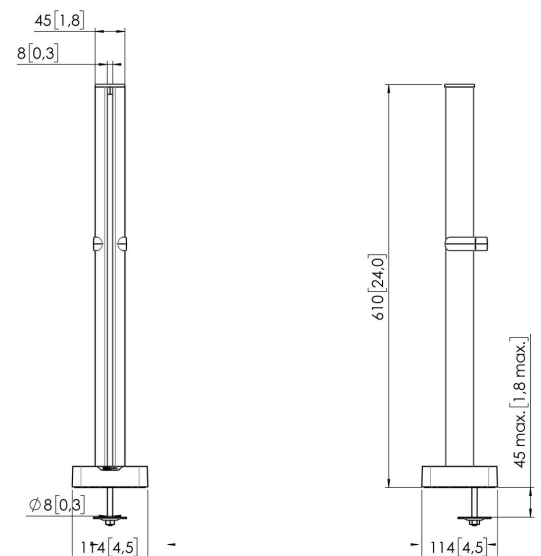
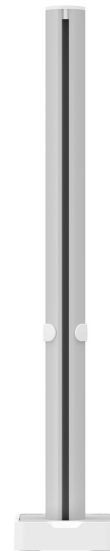



MOMO C160 Base with Pole Component, for Motion and Motion Plus, 60 cm (white)

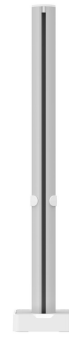

Specifications

Article number (SKU)	7161601
Colour	White
EAN single box	8712285354120
Height	610
Width	114
Depth	114
TÜV certified	Yes
Guarantee	10 years
Mounting Possibilities	On and through desk

VOGEL'S HOLDING BV (©)

All rights reserved.
Subject to printing errors,
technical and price
amendments.

Date: 2023-06-16



Vogel's. For Sure.